

A
B

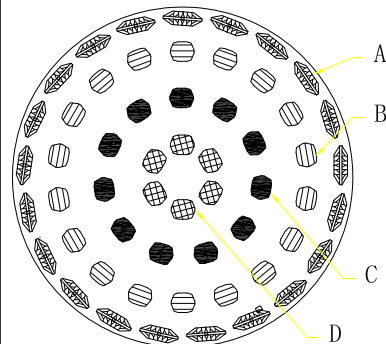

- A*21PCS
- B*18PCS
- C*11PCS
- D*6PCS

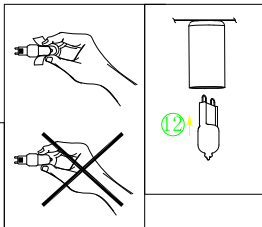
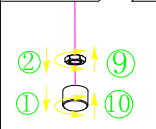
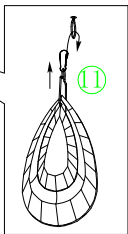
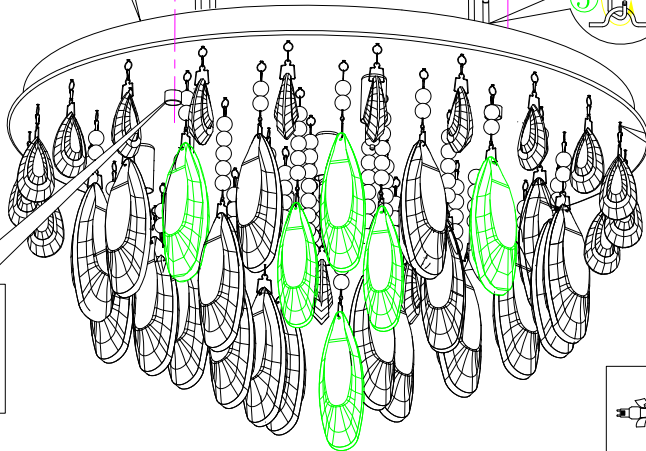
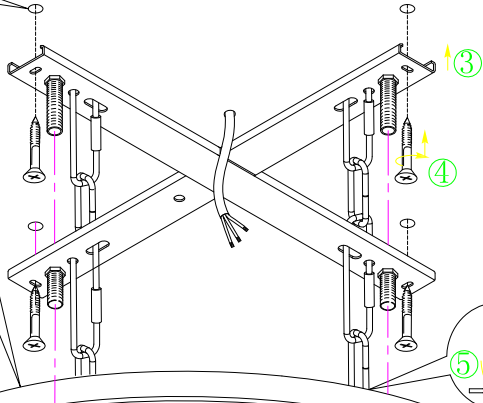
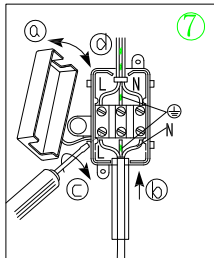
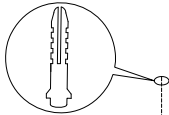
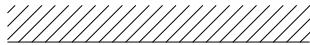
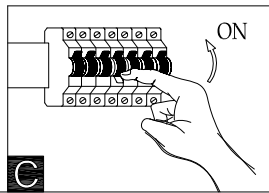

C